



VVF53..



VXF53..

ACVATIX™

2- and 3-port valves with flanged connections, PN 25

VVF53..

VXF53..

From the large-stroke valve line

- High-performance valves for medium temperatures from -20...220 °C
- Valve body of nodular cast iron EN-GJS-400-18-LT
- DN 15...150
- k_{vs} 0.16...400 m³/h
- Flange type 21, flange design B
- Equipable with electro-hydraulic actuators SAX.. or SKD.., SKB.., SKC..

Use





In boiler, district heating and refrigeration plants, cooling towers, heating groups, and in air handling units as control or shutoff valves.
For use in closed or open hydraulic circuits (observe cavitation).

上海顺鸣实业有限公司

Type summary

	Valves PN 25 PN 16 ¹⁾ 	Actuators			SAX.. ²⁾		SKD.. ²⁾		SKB..		SKC..									
		Stroke			800 N		20 mm		2800 N		40 mm									
		Positioning force			N4501		N4561		N4664		N4566									
		Data sheet			N4501		N4561		N4664		N4566									
Fluids	Stock number	DN	k _{vs} [m ³ /h]	S _v	Δp _s	Δp _{max}	Δp _s	Δp _{max}	Δp _s	Δp _{max}	Δp _s	Δp _{max}								
													[kPa]							
	VVF53.15-0.16	S55208-V100	15	0.16	2500	1200	2500	1200	2500	1200	-	-								
	VVF53.15-0.2	S55208-V101	15	0.2																
	VVF53.15-0.25	S55208-V102	15	0.25																
	VVF53.15-0.32	S55208-V103	15	0.32																
	VVF53.15-0.4	S55208-V104	15	0.4																
	VVF53.15-0.5	S55208-V105	15	0.5																
	VVF53.15-0.63	S55208-V106	15	0.63																
	VVF53.15-0.8	S55208-V107	15	0.8																
	VVF53.15-1	S55208-V108	15	1																
	VVF53.15-1.25	S55208-V109	15	1.25																
	VVF53.15-1.6	S55208-V110	15	1.6																
	VVF53.15-2	S55208-V111	15	2																
	VVF53.15-2.5	S55208-V112	15	2.5																
	VVF53.15-3.2	S55208-V113	15	3.2																
	VVF53.15-4	S55208-V114	15	4																
	VVF53.20-6.3	S55208-V116	20	6.3	1600	750	2100	1100	2000	-	-									
	VVF53.25-5	S55208-V117	25	5																
	VVF53.25-6.3	S55208-V118	25	6.3																
	VVF53.25-8	S55208-V119	25	8																
	VVF53.25-10	S55208-V120	25	10																
	VVF53.32-16	S55208-V122	32	16																
	VVF53.40-12.5	S55208-V123	40	12.5																
	VVF53.40-16	S55208-V124	40	16																
	VVF53.40-20	S55208-V125	40	20																
	VVF53.40-25	S55208-V126	40	25																
	VVF53.50-31.5	S55208-V127	50	31.5	350	300	450	400	1200	1150	-	-								
	VVF53.50-40	S55208-V128	50	40																
	VVF53.65-63 ³⁾	S55208-V129	65	63																
	VVF53.80-100 ³⁾	S55208-V130	80	100																
	VVF53.100-160 ³⁾	S55208-V131	100	160																
	VVF53.125-250 ³⁾	S55208-V132	125	250																
	VVF53.150-400	S55208-V133	150	400																
	VVF53.15-0.16	S55208-V100	15	0.16									-	-	2500	1200	2500	1200	-	-
	VVF53.15-0.2	S55208-V101	15	0.2																
	VVF53.15-0.25	S55208-V102	15	0.25																
	VVF53.15-0.32	S55208-V103	15	0.32																
	VVF53.15-0.4	S55208-V104	15	0.4																
	VVF53.15-0.5	S55208-V105	15	0.5																
	VVF53.15-0.63	S55208-V106	15	0.63																
	VVF53.15-0.8	S55208-V107	15	0.8																
	VVF53.15-1	S55208-V108	15	1																
	VVF53.15-1.25	S55208-V109	15	1.25																
	VVF53.15-1.6	S55208-V110	15	1.6																
	VVF53.15-2	S55208-V111	15	2																
	VVF53.15-2.5	S55208-V112	15	2.5																
	VVF53.15-3.2	S55208-V113	15	3.2																
	VVF53.15-4 ⁵⁾	S55208-V114	15	3.6																
	VVF53.20-6.3 ⁵⁾	S55208-V116	20	5	1000	600	-	-												
	VVF53.25-5	S55208-V117	25	5																
	VVF53.25-6.3	S55208-V118	25	6.3																
	VVF53.25-8	S55208-V119	25	8																
	VVF53.25-10 ⁵⁾	S55208-V120	25	8																
	VVF53.32-16 ⁵⁾	S55208-V122	32	15																
	VVF53.40-12.5	S55208-V123	40	12.5																
	VVF53.40-16	S55208-V124	40	16																
	VVF53.40-20	S55208-V125	40	20																
	VVF53.40-25 ⁵⁾	S55208-V126	40	23																
	VVF53.50-31.5	S55208-V127	50	31.5	600	-	-	-												
	VVF53.50-40	S55208-V128	50	40																

上海顺鸣实业有限公司

	Valves PN 25 PN 16 ¹⁾ 	Actuators Stroke Positioning force Data sheet				SAX.. ²⁾		SKD.. ²⁾		SKB..		SKC..	
		Stock number	DN	k _{vs} [m ³ /h]	S _v	20 mm		2800 N		2800 N		2800 N	
						Δp _s	Δp _{max}	Δp _s	Δp _{max}	Δp _s	Δp _{max}	Δp _s	Δp _{max}
Steam ⁴⁾		VVF53.65-63	S55208-V129	65	63	> 100	-	-	-	-	-	-	1000
	VVF53.80-100	S55208-V130	80	100	750								
	VVF53.100-160 ⁵⁾	S55208-V131	100	150	500								
	VVF53.125-250 ⁵⁾	S55208-V132	125	220	300								
	VVF53.150-400 ⁵⁾	S55208-V133	150	360	200								
													
Fluids													
		VXF53.15-1.6	S55208-V140	15	1.6	> 100	-	-	-	-	-	-	-
	VXF53.15-2.5	S55208-V141	15	2.5									
	VXF53.15-4	S55208-V142	15	4									
	VXF53.20-6.3	S55208-V144	20	6.3									
	VXF53.25-6.3	S55208-V145	25	6.3									
	VXF53.25-10	S55208-V146	25	10									
	VXF53.32-16	S55208-V148	32	16									
	VXF53.40-16	S55208-V149	40	16									
	VXF53.40-25	S55208-V150	40	25									
	VXF53.50-40	S55208-V152	50	40									
	VXF53.65-63 ³⁾	S55208-V153	65	63									
	VXF53.80-100 ³⁾	S55208-V154	80	100									
	VXF53.100-160 ³⁾	S55208-V155	100	160									
	VXF53.125-250 ³⁾	S55208-V156	125	250									
	VXF53.150-400	S55208-V157	150	400									

¹⁾ DN 15...50: Flange dimensions for PN 16 and PN 25

DN 65...150: Flange dimensions only for PN 25

²⁾ Usable up to a max. medium temperature of 150 °C

³⁾ Valve characteristic for k_{vs} value 63 m³/h from 90% stroke, k_{vs} value 100, 160 and 250 m³/h from 80% stroke is optimized for maximum volumetric flow

⁴⁾ Operate with opposite flow direction with steam

⁵⁾ Reduced k_{vs} value

DN = Nominal size

k_{vs} = Flow nominal value of cold water (5...30 °C) through the fully opened valve (H₁₀₀) at a differential pressure of 100 kPa (1 bar)

S_v = Rangeability

Δp_s = Maximum permissible differential pressure at which the motorized valve still closes securely against the pressure

Δp_{max} = Maximum permissible differential pressure across the valve's throughport for the entire positioning range of the motorized valve

Note

When using a stem heating element with a medium temperature of below -5 °C, the stem sealing gland must be replaced. In this case, the sealing gland must be ordered separately (Stock number: 4 284 8806 0).

Ordering

Example

Product number	Stock number	Description
VXF53.25-6.3	S55208-V145	3-port valve with flange, PN 25
SAX31.03	S55150-A106	Electro-hydraulic actuator

Delivery

Valves, actuators and accessories are packed and delivered as separate items.

Note

Counter-flanges, bolts and gaskets must be provided on site.

Spare parts, Rev.-Nr.

See page 13

上海顺鸣实业有限公司

Equipment combinations

Product number	Description	Stroke	Positioning force	Operating voltage	Positioning signal	Spring return time	Positioning time	LED	Manual adjuster	Auxiliary functions
SAX31.00	S55150-A105	20 mm	800 N	AC 230 V	3-position	-	120 s	-	Push and fix	1) 2), 3)
SAX31.03	S55150-A106						30 s			
SAX61.03	S55150-A100				3-position	-	120 s	-	Push and fix	1)
SAX61.03U	S55150-A100-A100						30 s			
SAX81.00	S55150-A102						30 s			
SAX81.03	S55150-A103	20 mm	1000 N	AC 230 V	3-position	-	Opening: 30 s Closing: 10 s	-	Turn, Position is maintained	1)
SAX81.03U	S55150-A103-A100						120 s			
SKD32.21	SKD32.21	20 mm	1000 N	AC 230 V	3-position	-	120 s	-	Turn, Position is maintained	2) 4)
SKD32.50	SKD32.50						8 s			
SKD32.51	SKD32.51				8 s					
SKD60	SKD60				15 s					
SKD62	SKD62			AC 24 V	3-position	-	120 s	-	1)	
SKD62U	SKD62U									
SKD62UA	SKD62UA									
SKD82.50	SKD82.50									
SKD82.50U	SKD82.50U	AC 230 V	3-position	-	120 s	-	1)			
SKD82.51	SKD82.51									
SKD82.51U	SKD82.51U	20 mm	2800 N	AC 230 V	3-position	-	120 s	-	Turn, Position is maintained	1) 2) 4)
SKB32.50	SKB32.50						10 s			
SKB32.51	SKB32.51				10 s					
SKB60	SKB60			AC 24 V	3-position	-	120 s	-	1)	
SKB62	SKB62									
SKB62U	SKB62U									
SKB62UA	SKB62UA									
SKB82.50	SKB82.50	AC 230 V	3-position	-	120 s	-	1)			
SKB82.50U	SKB82.50U									
SKB82.51	SKB82.51									
SKB82.51U	SKB82.51U	40 mm	2800 N	AC 230 V	3-position	-	120 s	-	Turn, Position is maintained	1) 2) 4)
SKC32.60	SKC32.60						18 s			
SKC32.61	SKC32.61			20 s						
SKC60	SKC60			AC 24 V	3-position	-	120 s	-	1)	
SKC62	SKC62									
SKC62U	SKC62U									
SKC62UA	SKC62UA			AC 230 V	3-position	-	120 s	-	1)	
SKC82.60	SKC82.60									
SKC82.60U	SKC82.60U									
SKC82.61	SKC82.61	AC 24 V	3-position	-	120 s	-	1)			
SKC82.61U	SKC82.61U									

- 1) Auxiliary switch, potentiometer
 2) Position feedback, forced control, selection of valve characteristic
 3) Optional: Sequence control, selection of acting direction
 4) Plus sequence control, stroke limitation, and selection of acting direction

Product documentation





- Mounting Instructions M4030 74 319 0749 0
- Basic documentation P4030 Contains background information and technical basic knowledge of valves

Technical and mechanical design

The illustrations below show the basic design of the valves. Constructional features, such as the shape of plugs, may differ.

上海顺鸣实业有限公司

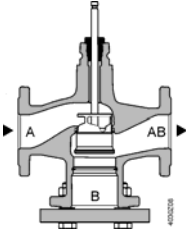
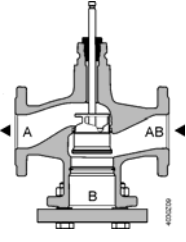

2-port valves

 Fluids	 Steam
 Closing against the pressure	 Closing with the pressure
 A → AB	 A ← AB



Note

2-port valves do not become 3-port valves by removing the blank flange!

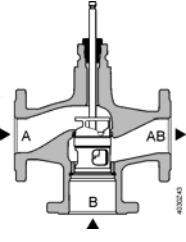
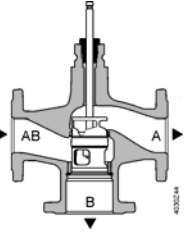
3-port valves

 Fluids	
 Mixing valve (preferred use)	 Diverting valve
 A + B → AB	 AB → A + B

Accessories

Product number	Stock number	Description	Note	
ASZ6.5	ASZ6.5	Stem heating element	Required for medium temperatures < 0 °C	
ASZ6.6	S55845-Z108			
-	428488060	Stem sealing gland	When using valves of the V..F53.. lines with a stem heating element and a medium temperature below -5 °C, the stem sealing gland must be replaced.	

Adapter type	Stock number	Bolts included	Description	VXF41..	
ALF41B15	S55845-Z110	4x M12x90mm	Adapter for replacing 3-port valves VXF41.. by VXF53.. • Due to different dimensions of the bypass flange • Every valve to be replaced requires an adapter • Adapter is supplied with the required number and size of bolts and nuts as well as two suitable flat sealings Replace 3-port valves VXF41.., DN 65...150 by 3-port valves VXF43.. (data sheet N4404).	DN 15	 DN 15
ALF41B25	S55845-Z111	4x M12x90mm		DN 25	
ALF41B40	S55845-Z112	4x M16x90mm		DN 40	
ALF41B50	S55845-Z113	4x M16x90mm		DN 50	

上海顺鸣实业有限公司

Sizing

Flow chart

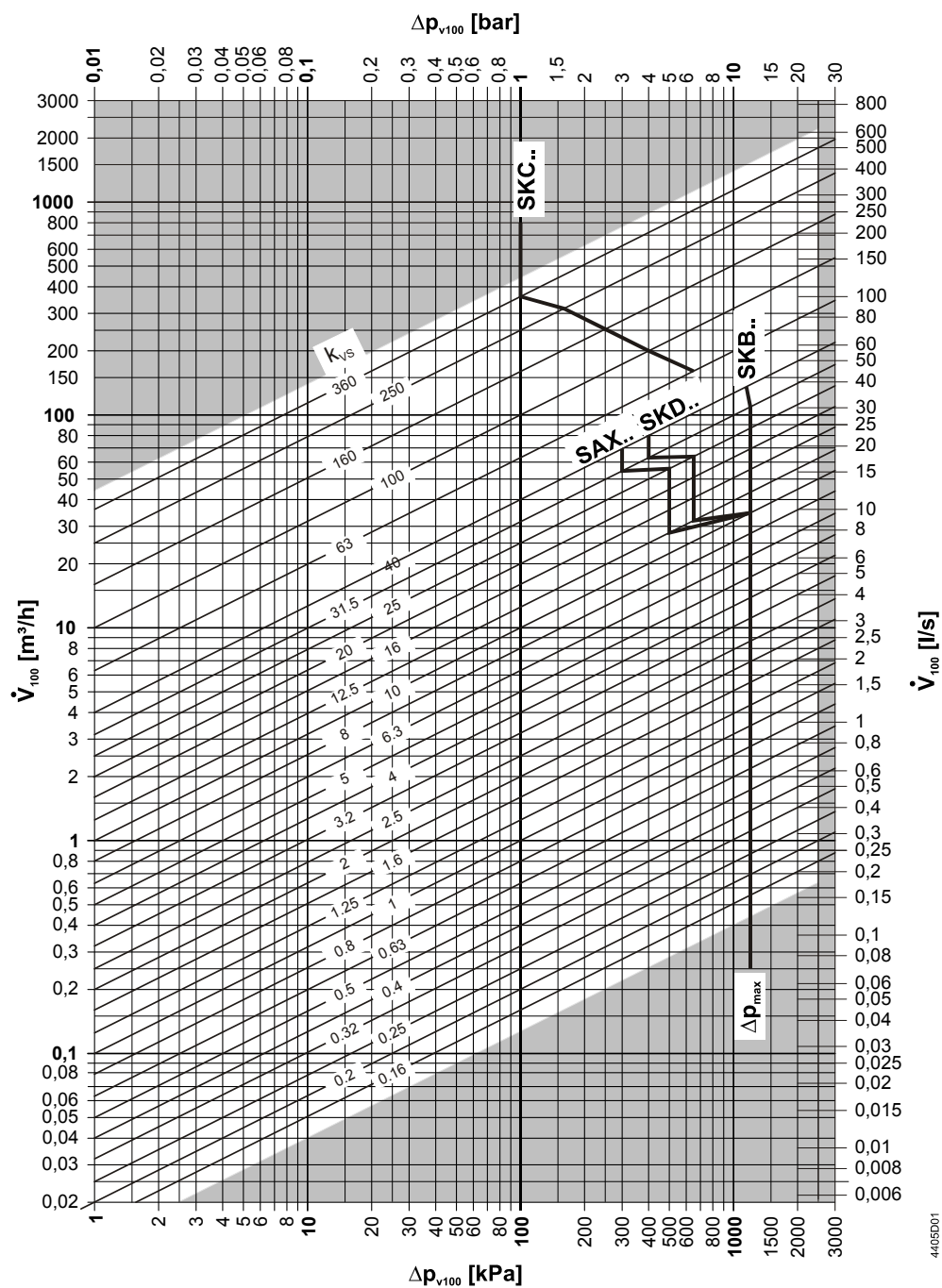

Δp_{max} values apply for the mixing function. Δp_{max} values for the diverting function see table "Type summary", page 2

Δp_{max} values for k_{vs} value 16, DN 32, see table "Type summary", page 2

上海顺鸣实业有限公司

Valve characteristics 2-port valves

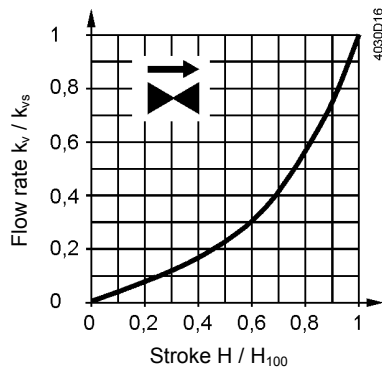

0...30%: Linear
30...100%: Equal percentage
 $n_{gl} = 3$ to VDI / VDE 2173

For high k_{vs} values the valve characteristic is optimized for maximum volumetric flow k_{V100} .

For product lines:
VVF53.125-250
VVF53.150-400

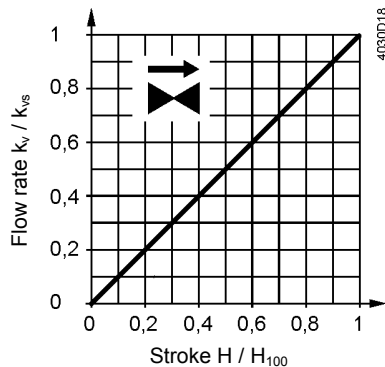

0...100%: Linear

3-port valves

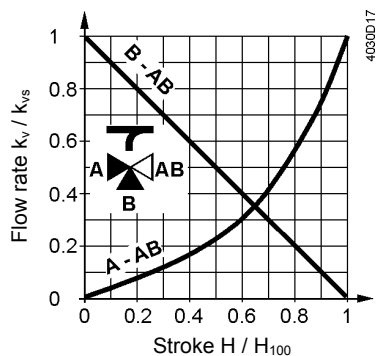

Throughport A-AB

0...30%: Linear
30...100%: Equal percentage
 $n_{gl} = 3$ to VDI / VDE 2173

For high k_{vs} values the valve characteristic is optimized for maximum volumetric flow k_{V100} .

Bypass B-AB

0...100%: Linear

Port AB = constant volumetric flow
Port A = variable volumetric flow
Port B = Bypass (variable volumetric flow)

Mixing: Volumetric flow from port A and port B to port AB
Diverting: Volumetric flow from port AB to port A and port B

For product lines:
VXF53.125-250
VXF53.150-400

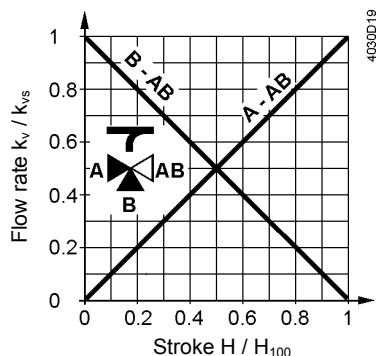

Throughport A-AB

0...100%: Linear

Bypass B-AB

0...100%: Linear

上海顺鸣实业有限公司

Operating pressure and medium temperature

Fluids with V..F53..

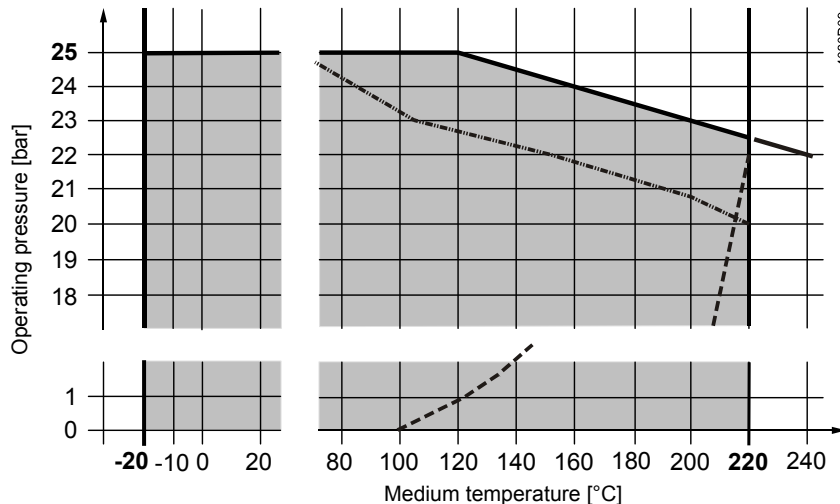

Operating pressure and operating temperatures according to ISO 7005, EN 1092 and EN 12284

Notes

- All relevant local directives must be observed

Saturated steam
Superheated steam
with VVF53..

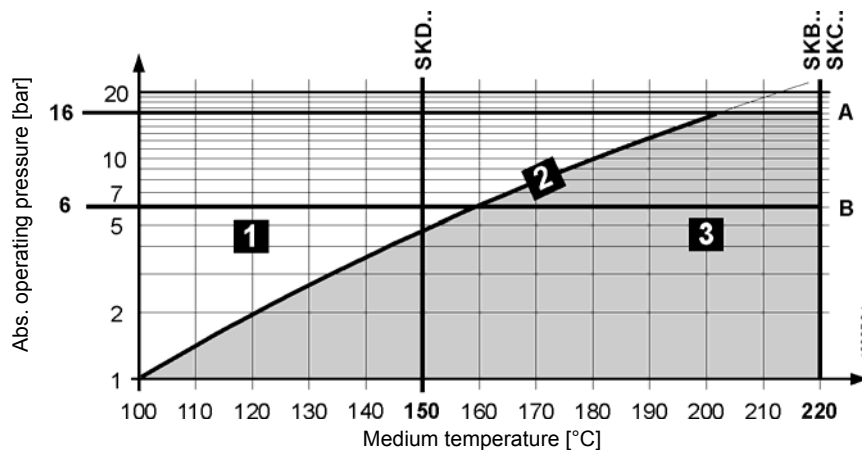

1	Wet steam	To be avoided
2	Saturated steam	Permissible operating range
3	Superheated steam	
A	Subcritical pressure ratio	
B	Supercritical pressure ratio	

上海顺鸣实业有限公司

Medium compatibility and temperature ranges

Medium	Temperature range		Valve		Note
	T _{min} [°C]	T _{max} [°C]	VVF53..	VXF53..	
Cold water	1	25	■	■	-
Hot water	1	130	■	■	-
High-temperature hot water ¹⁾	130	150	■	■	-
	150	180	■	■	-
	180	220	■	■	-
Water with antifreeze	-5	150	■	■	V..F53: With a medium temperature of below -5 °C, the stem sealing gland must be replaced
	-10	150	■	■	
	-20	150	■	■	
Cooling water ²⁾	1	25	■	■	-
Brines	-5	150	■	■	V..F53: With a medium temperature of below -5 °C, the stem sealing gland must be replaced
	-10	150	■	■	
	-20	150	■	■	
Saturated steam ³⁾	100	150	■	-	-
	100	220	■	-	-
Superheated steam	120	150	■	-	-
	120	220	■	-	-
Heat transfer oils	20	220	■	■	On the basis of mineral oil
Super-clean water (demineralized and deionized)	1	150	-	-	

¹⁾ Differentiation due to saturated steam curve

²⁾ Open circuits

³⁾ Operate with inverted flow direction with steam

Fields of use

Fields of use		Valve	
		VVF53..	VXF53..
Generation	Boiler plants	■	■
	District heating plants	■	-
	Refrigeration plants	■	■
	Cooling towers ¹⁾	■	■
Distribution	Heating groups	■	■
	Air handling units	■	■

¹⁾ Open circuits

Engineering notes

Mounting location

Preferably mount the valves at the return, as the temperature is lower there and the strain on the stem sealing gland is lower.

Operate valves of the product lines VVF53.. with inverted flow direction for steam.

Dirt trap

Mount a dirt filter or dirt trap before the valve to ensure proper functioning, and a long service life of the valve.

Cavitation

Remove dirt, welding beads, etc. from the valves and pipes.

Cavitation can be avoided by limiting the pressure differential across the valve depending on the medium temperature and the prepressure.

Mounting notes

Mounting position

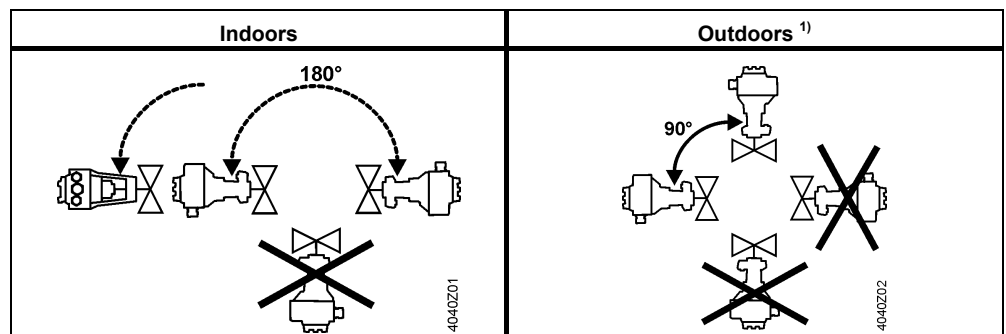

¹⁾ Only in combination with weather shield ASK39.1 and actuators SAX..

Mounting positions apply to both 2- and 3-port valves.

上海顺鸣实业有限公司

Commissioning notes



The valve may be put into operation only if actuator and valve are correctly assembled.

Note

Ensure that actuator stem and valve stem are rigidly connected in all positions.

Function check

Valve	Throughport A→AB	Bypass B→AB
Valve stem extends	Closes	Opens
Valve stem retracts	Opens	Closes

Maintenance notes

The valves are maintenance-free.



When servicing valves or actuators:

- Deactivate the pump and turn off the power supply
- Close the shutoff valves
- Fully reduce the pressure in the piping system and allow pipes to completely cool down

If necessary, disconnect the electrical wires.

Disposal



Due to the different types of material used, the valve must be disassembled prior to disposal. Special handling of certain valve components may be required by law or may be sensible from an ecological point of view.

Local and currently valid legislation must be observed.

Warranty

Application-related technical data are guaranteed only when the valves are used in connection with the Siemens actuators listed under "Equipment combinations", page 3.

When used with actuators of other manufacture, any warranty by Siemens becomes void.

上海顺鸣实业有限公司

Technical Data

Functional data	PN class	PN 25	
	Connection	Flange	
	Operating pressure	See Section "Operating pressure and medium temperatures" page 8	
	Valve characteristics ¹⁾	See section "Valve characteristics", page 7	
	Leakage rate	Throughport	0...0.01% of k_{vs} value (Class IV)
		Bypass	0.5...2% of k_{vs} value with SKD..., SKB..., SKC.. 0.05% of k_{vs} value with SAX..
	Permissible media	See table " Medium compatibility and temperature ranges", page 9	
	Medium temperature	-20...220 °C ²⁾	
	Rangeability	DN 15, $k_{vs} \leq 1.25 \text{ m}^3/\text{h}$: >50	
		DN 15...150: >100	
Nominal stroke	Up to DN 50: 20 mm From DN 65: 40 mm		
Materials	Valve body / Blank flange	EN-GJS-400-18-LT / P265GH	
	Valve stem, seat, plug	Stainless steel	
	Stem sealing gland	Stainless steel	
		FEPM (silicone-free)	
Adapter ALF41B..	Steel S235JRG2		
Standards	Pressure Equipment Directive	PED 97/23/EC	
	Pressure-carrying accessories	According to article 1, section 2.1.4	
	Fluid group 2	PN 25	
		without CE certification according to article 3, section 3 (good engineering practice)	$\leq \text{DN } 40$
		Category I, with CE certification	DN 50...100
	Category II, with CE certification, notified body identification number 0036	DN 125...150	
	PN class	ISO 7268	
	Operating pressure	ISO 7005, DIN EN 12284	
	Flanges	ISO 7005	
	Length of flanged valves	DIN EN 558-1, line 1	
	Valve characteristic	VDI 2173	
	Leakage rate	Throughport, Bypass according to EN 60534-4 / EN 1349	
	Water treatment	VDI 2035	

上海顺鸣实业有限公司

Environmental conditions

Storage: IEC 60721-3-1
Transport: IEC 60721-3-2
Operation: IEC 60721-3-3

Class	1K3
Temperature	-15...+55 °C
Rel. humidity	5...95% r.H.
Class	2K3, 2M2
Temperature	-30...+65 °C
Rel. humidity	< 95% r.H.
Class	3K5, 3Z11
Temperature	-15...+55 °C
Rel. humidity	5...95% r.H.

Environmental compatibility

ISO 14001 (environment)
 ISO 9001 (quality)
 SN 36350 (environmentally compatible products)
 RL 2002/95/EG (RoHS)

Dimensions / Weight

Dimensions

See „Dimensions“, page 12

Weight

See „Dimensions“, page 12

- For certain valve lines and high k_{vs} values, the valve characteristic is optimized for maximum volumetric flow k_{V100}
- For medium temperatures < -5 °C, the stem sealing gland must be replaced. The sealing gland must be ordered separately (Stock number: 4 284 8806 0).

Dimensions

VVF53..

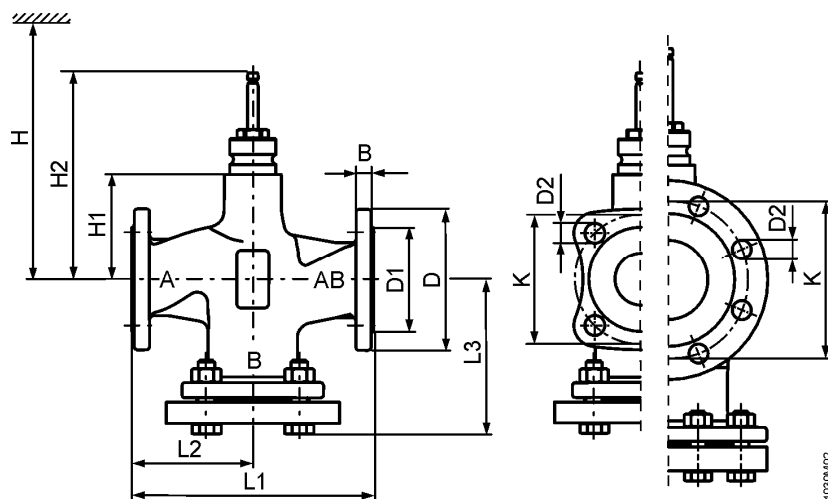

Product number	DN	kg	B	Ø D	Ø D1	Ø D2	L1	L2	L3	Ø K	H1	H2	H			
													SAX..	SKD..	SKB..	SKC..
VVF53..	15	4.2	14	95	46	14 (4x)	130	65	87.5	65	63	159.5	505	563	638	-
	20	5.4	16	105	56	14 (4x)	150	75	99.5	75	63	144.4	505	563	638	-
	25	6.1	15	115	65	14 (4x)	160	80	104.5	85	63	159.5	505	563	638	-
	32	8.8	17	140	76	19 (4x)	180	90	119	100	60	156.5	502	560	635	-
	40	10.2	16	150	84	19 (4x)	200	100	129	110	60	156.5	502	560	635	-
	50	13.7	16	165	99	19 (4x)	230	115	146	125	100	196.5	542	600	675	-
	65	21.8	17	185	118	19 (8x)	290	145	178	145	115	231.5	-	-	-	690
	80	28.1	17	200	132	19 (8x)	310	155	190	160	115	231.5	-	-	-	690
	100	38	17	235	156	23 (8x)	350	175	212.5	190	146	262.5	-	-	-	721
	125	51.9	17	270	184	28 (8x)	400	200	242	220	159	275.5	-	-	-	734
	150	74.1	17	297	211	28 (8x)	480	240	284	250	186.5	303	-	-	-	762

上海顺鸣实业有限公司

VXF53..

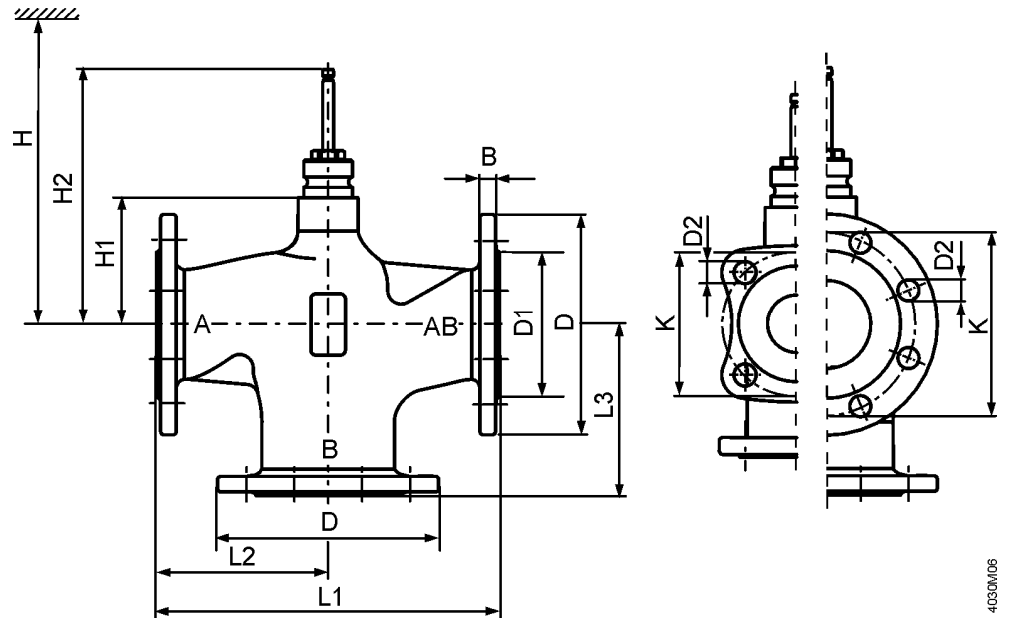

4030M06

Product number	DN	kg	B	Ø D	Ø D1	Ø D2	L1	L2	L3	Ø K	H1	H2	H			
													SAX..	SKD..	SKB..	SKC..
VXF53..	15	3.2	14	95	46	14 (4x)	130	65	65	65	63	159.5	505	563	638	-
	20	4.1	16	105	56	14 (4x)	150	75	75	75	63	159.5	505	563	638	-
	25	4.6	15	115	65	14 (4x)	160	80	80	85	63	159.5	505	563	638	-
	32	6.1	17	140	76	19 (4x)	180	90	90	100	60	156.5	502	560	635	-
	40	7.2	16	150	84	19 (4x)	200	100	100	110	60	156.5	502	560	635	-
	50	9.8	16	165	99	19 (4x)	230	115	115	125	100	196.5	542	600	675	-
	65	16.8	17	185	118	19 (8x)	290	145	145	145	115	231.5	-	-	-	690
	80	21.2	17	200	132	19 (8x)	310	155	155	160	115	231.5	-	-	-	690
	100	29	17	235	156	23 (8x)	350	175	175	190	146	262.5	-	-	-	721
	125	39.7	17	270	184	28 (8x)	400	200	200	220	159	275.5	-	-	-	734
	150	57	17	297	211	28 (8x)	480	240	240	250	186.5	303	-	-	-	762

Spare parts

Stem sealing gland

Product number	DN	Stock number	Comments	
VVF53.. VXF53..	DN 15...150	74 284 0061 0	-	
		4 284 8806 0	When operating with medium temperatures below -5 °C	

上海顺鸣实业有限公司

Revision numbers

Product number	Valid from rev. no.	Product number	Valid from rev. no.
VVF53.15-0.16	..A	VXF53.15-1.6	..A
VVF53.15-0.2	..A	VXF53.15-2.5	..A
VVF53.15-0.25	..A	VXF53.15-4	..A
VVF53.15-0.32	..A	VXF53.20-6.3	..A
VVF53.15-0.4	..A	VXF53.25-6.3	..A
VVF53.15-0.5	..A	VXF53.25-10	..A
VVF53.15-0.63	..A	VXF53.32-16	..A
VVF53.15-0.8	..A	VXF53.40-16	..A
VVF53.15-1	..A	VXF53.40-25	..A
VVF53.15-1.25	..A	VXF53.50-40	..A
VVF53.15-1.6	..A	VXF53.65-63	..A
VVF53.15-2	..A	VXF53.80-100	..A
VVF53.15-2.5	..A	VXF53.100-160	..A
VVF53.15-3.2	..A	VXF53.125-250	..A
VVF53.15-4	..A	VXF53.150-400	..A
VVF53.20-6.3	..A		
VVF53.25-5	..A		
VVF53.25-6.3	..A		
VVF53.25-8	..A		
VVF53.25-10	..A		
VVF53.32-16	..A		
VVF53.40-12.5	..A		
VVF53.40-16	..A		
VVF53.40-20	..A		
VVF53.40-25	..A		
VVF53.50-31.5	..A		
VVF53.50-40	..A		
VVF53.65-63	..A		
VVF53.80-100	..A		
VVF53.100-160	..A		
VVF53.125-250	..A		
VVF53.150-400	..A		